

TANITA®
A Step Toward A Healthier Life.

BF-541 BODY FAT MONITOR/SCALE

Instruction Manual

Read this Instruction Manual carefully
and keep it for future reference.



Table of Contents

Introduction	1
 Safety Precautions	
Important Notes for Users	
Principles of Estimating Body Fat Percentage	2 – 3
What is Body Fat Percentage?	
Body Fat Ranges	
The BIA Method	
Body Fat Percentage Fluctuations in a Day	
Advantages of the Tanita BF-541	
Features and Functions	3 – 4
Components	
Measuring Platform	
Accessories	
Useful Features of the BF-541	
Preparations Before Use	4 – 5
Inserting the Batteries	
Positioning the Monitor	
Attaching the Support Feet	
Setting and Storing Data in Memory	
Getting Accurate Readings	
Taking Readings	6
Taking Weight Measurement Only	
Guest Measurements	
Replacing the Batteries	
Handling Tips	7
Troubleshooting	7
Specifications	7
Warranty	8

Federal Communications Commission Notice

This equipment has been tested and found to comply with the limits for a Class B digital device, pursuant to Part 15 of the FCC Rules. These limits are designed to provide reasonable protection against harmful interference in a residential installation. This equipment generates, uses and can radiate radio frequency energy and, if not installed and used in accordance with the instructions, may cause harmful interference to radio communications. However, there is no guarantee that interference will not occur in a particular installation. If this equipment does cause harmful interference to radio or television reception, which can be determined by turning the equipment off and on, the user is encouraged to try to correct the interference by one or more of the following measures:

- Reorient or relocate the receiving antenna.
- Increase the separation between the equipment and receiver.
- Connect the equipment into an outlet on a circuit different from that to which the receiver is connected.
- Consult the dealer or an experienced radio or television technician for help.

Modifications

The FCC requires the user to be notified that any changes or modifications made to this device that are not expressly approved by Tanita Corporation may void the user's authority to operate the equipment.

Introduction

Thank you for selecting the Tanita Body Fat Monitor/Scale BF-541. This family model uses the BIA (Bioelectrical Impedance Analysis) technique, a state-of-the-art technology for body fat assessment.

Safety Precautions

- **Persons with implanted medical equipment, such as a pacemaker, should not use the BF-541. This Body Fat Monitor/Scale passes a low-level electrical signal through the body, which may interfere with the operation of a pacemaker.**
- The Tanita Body Fat Monitor/Scale BF-541 is intended for home use only. This unit is not intended for professional use in hospitals or other medical facilities; it is not equipped with the quality standards required for heavy usage experienced under professional conditions.
- Do not use this unit on slippery surfaces such as wet floors.
- Disabled people should be assisted by someone else, or use a handrail when using the BF-541.

Note: Body fat percentage estimates will vary with the amount of moisture in the body, and can be affected by dehydration or overhydration due to such factors as alcohol consumption, menstruation, illness, intense exercise, etc.

Important Notes for Users

The BF-541 is intended for use by adults and children with moderately active to inactive lifestyles. It is not intended for people with athletic body types.

Tanita defines “athlete” as a person involved in intense physical activity of at least 10 hours per week and who has a resting heart rate of approximately 60 beats per minute or less. Tanita’s athlete definition includes “lifetime of fitness” individuals who have been fit for years but currently exercise less than 10 hours per week.

Tanita’s athlete definition does not include “enthusiastic beginners” who are making a real commitment to exercising at least 10 hours per week but whose bodies have not yet changed to require the Athlete mode.

People with athletic body types should use Tanita Body Fat Monitor/Scales equipped with Athlete mode.

Body fat percentage estimates may be slightly lower or higher for the following categories of people:

- Adults seventy years old or older
- Persons undergoing dialysis
- Persons suffering from edema

Body fat percentage estimates for these persons should not be treated as absolute values, but may be used as relative values for checking body fat percent variations over a period of time.

The BF-541 is not intended for pregnant women, professional athletes or bodybuilders.

Recommendations for exercise programs or diets based on calculated data should be determined by a doctor or licensed medical professional. Do not attempt to evaluate the data by yourself.

Recorded data may be lost if the BF-541 is used incorrectly or is exposed to electrical power surges. Tanita takes no responsibility for any kind of loss caused by the loss of recorded data.

Tanita takes no responsibility for any kind of damage or loss caused by these units, or any kind of claim made by a third person.

Principles of Estimating Body Fat Percentage

The Tanita Body Fat Monitor/Scale BF-541 allows you to estimate your body fat percentage at home as easily as you measure your weight.

What is Body Fat Percentage?

Body fat percentage is the percentage of fat in your body. Until now, your absolute weight has determined whether or not you were considered overweight or obese. In recent years, the definition of obesity has been refined to mean the presence of excess body fat. Too much body fat has been linked to conditions such as high blood pressure, heart disease, diabetes, cancer, and other disabling conditions.

The chart below shows reasonable ranges of body fat percentage.

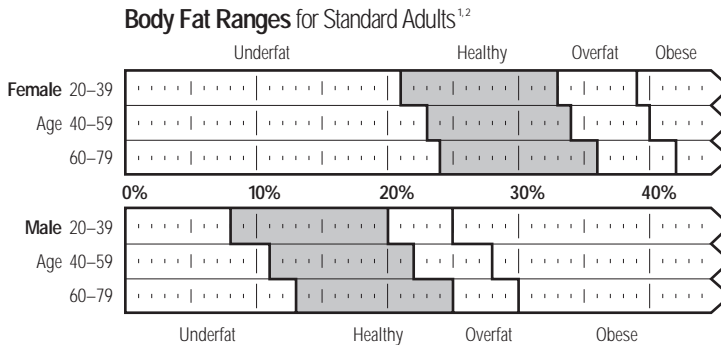

¹ Based on NIH/WHO BMI Guidelines.
² As reported by Gallagher, et al., at NY Obesity Research Center.
 To determine the percentage of body fat that is appropriate for your body, consult your physician.



Tanita's patented "foot-pad" design sends a safe, low-level electrical signal through the body to determine its composition.

The BIA Method

The BF-541 uses the BIA (Bioelectrical Impedance Analysis) technique. In this method, a safe low-level electrical signal is passed through the body. It is difficult for the signal to flow through fat in the human body, but easy to flow through moisture in the muscle and other body tissues. The difficulty with which a signal flows through a substance is called impedance. So the amount of fat in the body can be accurately estimated by measuring the impedance. The signal used is very low, making it safe and imperceptible.

The illustration on the left show how the signal travels through the body.

Body Fat Percentage Fluctuations in a Day

Hydration levels in the body may affect body fat readings. Readings are usually highest in the early waking hours, since the body tends to be dehydrated after a long night's sleep. For the most accurate reading, a person should take a body fat percentage reading at a consistent time of day under consistent conditions.

Besides this basic cycle of fluctuations in the daily body fat readings, variations may be caused by hydration changes in the body due to eating, drinking, menstruation, illness, exercising, and bathing. Daily body fat readings are unique to each person, and depend upon one's lifestyle, job and activities.

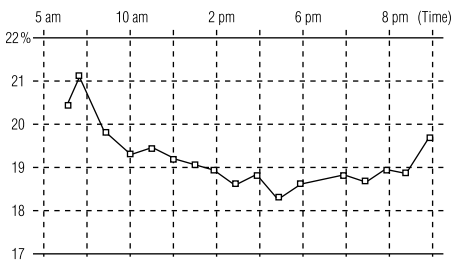

Daily fluctuations in body fat percentage based on the BIA technique.

The graph on the left shows an example of daily body fat percentage fluctuations.

Advantages of the Tanita BF-541

Previously, body fat percentage was determined by measuring the thickness of subcutaneous fat by pinching it with calipers, or by laying a person on a scanning bed and passing a current from hand to foot. However, these methods present problems—professional skills are required, the procedures take time and are often invasive, and measurement values vary. Currently, the gold standard methods of fat percentage measurement are DEXA (dual energy x-ray absorptiometry) and Hydrodensitometry (underwater weighing).

Tanita's BIA method uses equations derived from large, multi-ethnic population studies to predict body composition. Readings taken with Tanita's BF-541 correlate highly with both DEXA (Tanita's reference model) and Hydrodensitometry.

Features and Functions

Components

- | | |
|-----------------------|--------------------------|
| Measuring Platform | Warranty |
| Support Feet (4) | Educational Booklet |
| AA-Size Batteries (4) | Getting Started Workbook |
| Instruction Manual | |

Measuring Platform

1. Display Screen
2. Orange Set Button
3. Green Arrow (Select) Button
4. Toe Electrodes
5. Heel Electrodes
6. Guide Marks Sticker
For positioning heels when standing on the unit.
7. Personal Keys (Start Switches)
Setting of Adult or Child, Male or Female, and Height for four persons can be stored in the memory of the unit.
8. Weight Measurement Key
Use for weight measurement only.

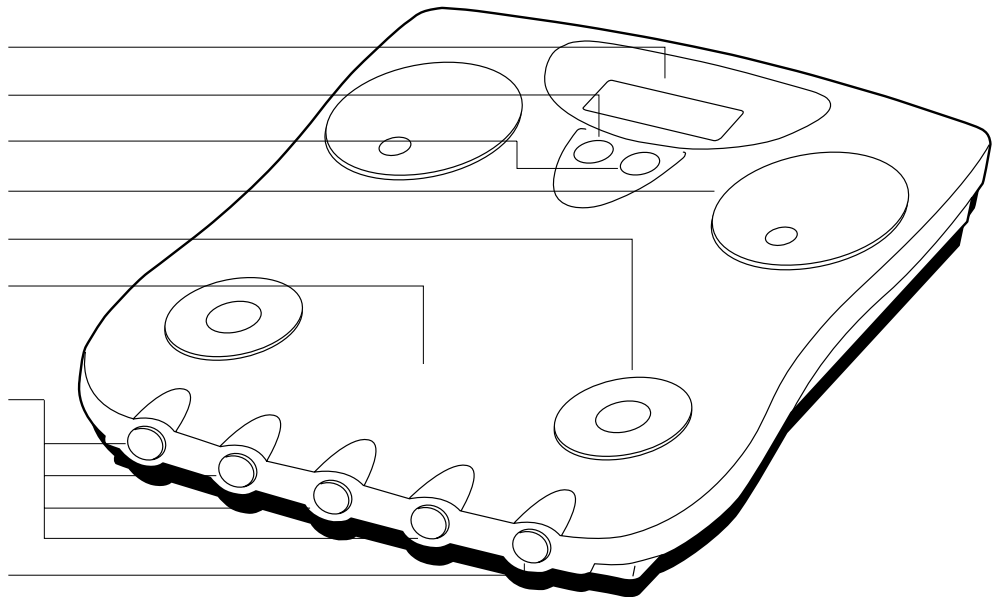

Accessories

9. Support Feet (4)
For use on carpeting only (max. recommended carpet thickness 0.8 in); a hard, uncarpeted surface is recommended.
10. AA-Size Batteries (4)

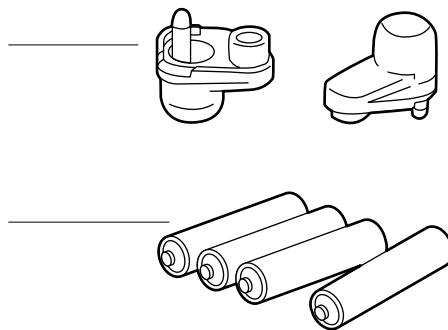

Useful Features of the BF-541

- The BF-541 allows you to measure both weight and body fat percentage simultaneously as easily and simply as stepping on a scale.
- The BF-541 can be set for an Adult or Child, Male or Female, increasing the accuracy of the reading.
- Personal data (Adult/Child, Male/Female and Height) can be stored in the memory of the unit for up to four people.
- Weight only key provides quick weight only readings.



Press the Green Arrow and Orange Set buttons simultaneously.



Press the Green Arrow button to choose your measurement mode (lb/kg/st-lb), then press the Orange Set button.

Switching the Weight Mode

The BF-541 can record measurements in lb (pounds), kg (kilograms) or st-lb (British stone pounds). To select the preferred mode, make sure the monitor is off. Press the Green Arrow and Orange Set buttons simultaneously. Press the Green Arrow button to choose your measurement mode (lb/kg/st-lb), then press the Orange Set button. The display screen will flash to confirm your selection and store it in memory. (To change weight mode, repeat the previous steps.)

Automatic Shut-Down Function

The automatic shut-down function shuts off the power automatically in the following cases:

- If you interrupt the measurement process. The power will shut down automatically within 10 to 20 seconds, depending upon the type of operation.
- If an extraordinary weight is applied to the platform.
- If you make a mistake during measurement or a key or button operation.
- After you have completed the measuring process.

Note: If the power shuts off unexpectedly, repeat the measuring process.

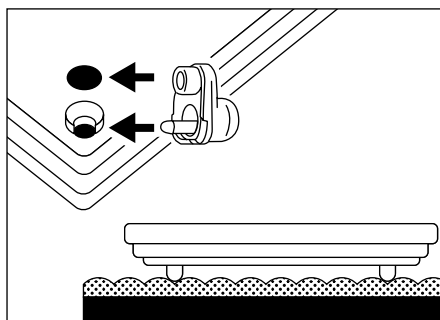
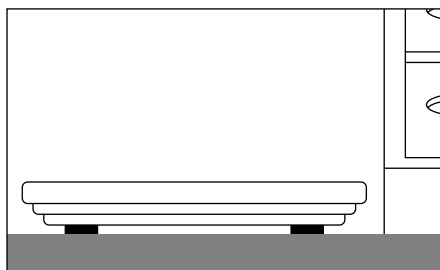
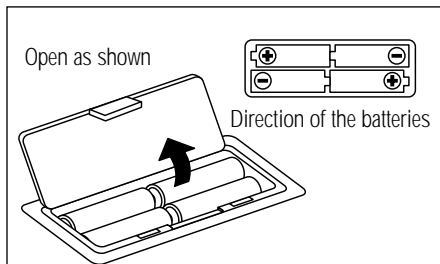

Preparations Before Use

Inserting the Batteries

1. Locate the battery cover on the back of the measuring platform. Press the tab to release the cover as shown.
2. Insert the supplied AA-size batteries as indicated.

⚠ Note: Be sure that the polarity of the batteries is set properly. If the batteries are incorrectly positioned, the fluid may leak and damage floors. If you do not intend to use this unit for a long period of time, it is advisable to remove the batteries before storage.

Positioning the Monitor

Place the monitor on a hard, flat surface where there is minimal vibration to ensure safe and accurate measurement.

⚠ Note: To avoid possible injury, do not step on the edge of the platform.

Attaching the Support Feet (Carpet Use Only)

Insert the support feet into the holes at the four corners on the bottom of the measuring platform.

Note: Do not use the monitor on any carpeting that is more than 0.8 inch in thickness.

⚠ Do not use the support feet on hard, flat surfaces, as the unit may tip over.

Setting and Storing Data in Memory

The BF-541 can be operated only if data has been preprogrammed into one of the four Personal keys. Once programmed, tapping a Personal key turns the monitor on. The unit has an automatic shut-down function. If you do not step on the platform after pressing a Personal key, the unit will automatically shut off in about 30 seconds.

The BF-541 is intended for use by adults and children who have moderately active to inactive lifestyles.

The BF-541 is not intended for use by persons with athletic body types. (See p.1 for Tanita's definition of "athlete.")

1. Turn on the Power

When programming data, use the Orange Set button to turn the unit on. The register numbers ("1-2-3-4") will appear and the display will flash.

2. Select a Personal Key

Use the Green Arrow button to select a Personal key, then press the Orange Set button.

3. Select Adult or Child

Use the Green Arrow button to specify Adult or Child, then press the Orange Set button.

Adult = age 18 or older.

Child = up to the age of 18, over 3 ft 4 in (102 cm).

4. Select Male or Female

Use the Green Arrow button to select Male or Female, then press the Orange Set button.

(♂) Male (♀) Female

5. Specify the Height

Use the Green Arrow button to specify Height in feet and inches. Then press the Orange Set button.

The display will flash all data (Adult/Child, Male/Female and Height) for three seconds to confirm the programming. The power will automatically turn off.

Getting Accurate Readings

To get the most accurate absolute values, readings should be taken without clothing and under consistent conditions of hydration. If you do not undress, always remove your socks or stockings, and be sure the soles of your feet are clean before stepping on the measuring platform. Stand erect on the platform.

Note: An accurate reading will not be possible if the soles of your feet are not clean, or if your knees are bent or you are in a sitting position.

It is best to take readings at the same time of day. Remember to wait about three hours after rising, eating, or hard exercise before taking measurements. While readings taken under other conditions may not have the same absolute values, they are accurate for determining the percentage of change as long as the readings are taken in a consistent manner. To monitor progress, compare weight and body fat percentage taken under the same conditions over a period of time.

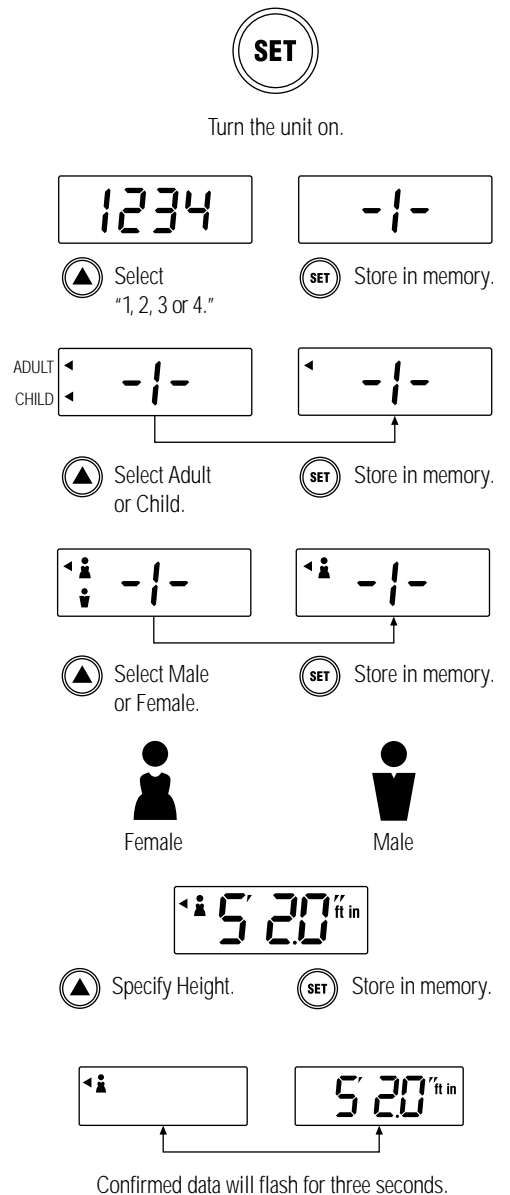

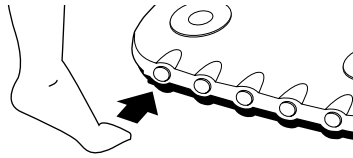

Turn the unit on by tapping your Personal key.

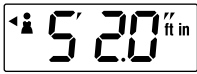

Your preset data will appear.



Wait for "0.0" to appear and step on.

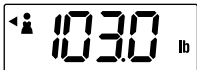

Your weight will be shown first.

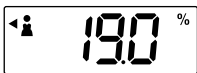

Your body fat percentage will be displayed.

Guest Measurements

The unit may be used by more than four persons. Simply repeat the programming process. (Steps 1 through 5 of Setting and Storing Data in Memory.)

Note: Previously stored data will be erased in the Personal key.

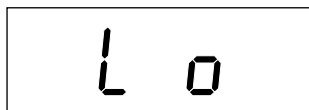
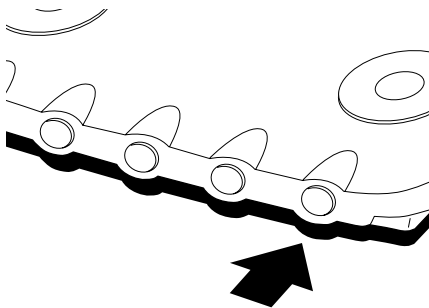

Batteries run low.

Taking Readings

1. Turn on the Power

Using your toe, turn the unit on by tapping your Personal key. Release the key within three seconds.

Your preset data will appear (Adult/Child, Male/Female and Height).

Immediately after your preset data, the display will show "0.0."

2. Take Reading

Wait for "0.0" to appear before stepping onto the measuring platform.

Note: If you step on before "0.0," you will not receive a reading.

Be sure you are barefoot, and that the soles of your feet are clean and dry.

Be sure that the heel and ball of each foot is directly on top of the electrodes on the measuring platform. Stand erect on the platform. Accurate readings can still be obtained even if your toes overhang the platform.

Note: If you do not step onto the measuring platform within about 20 seconds after "0.0" appears, the power shuts off automatically.

Your weight will be shown first. The numbers 5, 4, 3, 2, 1 will appear on the display. The numbers will disappear, and your body fat percentage will be displayed.

Continue to stand erect on the platform. The values of body fat percentage and body weight will be displayed alternately at two-second intervals. If you remain on the platform, the display will continue for about 30 seconds, and then the power will automatically turn off.

If you step off the platform, the alternating display of body fat percentage and body weight will be repeated three times, and then the power will automatically turn off.

Taking Weight Measurement Only

1. Select Weight Only Key

Using your toe, tap the weight only key to select weight measurement. After 2 or 3 seconds, "888" will appear in the display and then it will show "0.0 lb".

2. Take Measurement

Step onto the measuring platform.

The body weight will appear. If you remain on the platform, the display will flash for about 30 seconds, and then the power shuts off automatically. If you step off the platform, the weight will continue to show for about 5 seconds.

Replacing the Batteries

When the batteries run low, the "Lo" message will appear in the display window. When this message appears, be sure to replace the batteries immediately, since weak batteries will affect the accuracy of your readings.

Your setting will not be erased from the memory when you remove the batteries.

New batteries will last for about one year if the unit is used once every day. The unit comes with trial batteries; their service life will be short.

Handling Tips

This monitor is a precision instrument utilizing state-of-the-art technology. To keep the unit in the best condition, follow these instructions carefully:

- Do not attempt to disassemble the measuring platform.
- Store the unit horizontally, and place it so that the Personal keys will not be pressed accidentally.
- Avoid excessive impact or vibration to the unit.
- Place the unit in an area free from direct sunlight, heating equipment, high humidity, or extreme temperature change.
- Never submerge the unit in water. Use alcohol to clean the electrodes and glass cleaner to keep them shiny, applied to a cloth first; avoid soaps.
- When you change the batteries, exchange all four at the same time with new AA-size batteries.

Troubleshooting

If the following problems occur... then...

An unfamiliar weight reading appears followed by kg or st-lb.

Refer to “Switching the Weight Mode” on p.4.

Nothing appears in the display screen after initial display of preset data.

Check foot alignment. Make sure you wait for “0.0” to appear before stepping on the platform. Check to see that the batteries are fresh and are in the correct positions.

Nothing appears when a Personal key is pressed, or the display shows “- - - -” and goes off when a Personal key is pressed.

No data (Adult/Child, Male/Female or Height) has been stored in the memory of that Personal key.

The body fat percentage reading does not appear after the weight is measured.

Vibration will interfere with the fat percentage reading. Be sure to stand erect and still on the measuring platform. Do not bend your knees. Be sure that shoes and socks are removed and check foot alignment. Step off and repeat steps on p.6.

The body fat percentage reading is extremely low.

Be sure you have selected the correct user mode (Adult/Child, Male/Female), and that the soles of your feet are clean and properly aligned with the guides on the measuring platform. Consider whether or not you are overhydrated. Step off and repeat steps on p.6.

The body fat percentage reading is extremely high.

Be sure you have selected the correct user mode (Adult/Child, Male/Female), and that the soles of your feet are clean and properly aligned with the guides on the measuring platform. Dehydration, foot calluses, etc. will interfere with the fat percentage reading. Step off and repeat steps on p.6.

If you need assistance, please call our toll-free customer service number at 1-800-TANITA-8 (USA and Canada only).

Specifications

BF-541

Weight Capacity

300 lb (136 kg) (21 st-6 lb)

Weight Increments

0.5 lb (0.2 kg) (0.5 lb)

Body Fat Increments

0.5%

Power Supply

DC 6V AA-size (UM3-type) dry battery (x4)—included

Power Consumption

60 mA maximum

Measuring Current

50 kHz 500 μ A

After sales service

Please contact the store at which you bought this monitor for any inquiry regarding operation or trouble, request for repair and/or placement of an order for parts or products. Or call 1-800-TANITA-8 (USA and Canada only).

Tanita Products Limited Warranty

Not Valid Without Proof of Purchase

Your Tanita product is warranted to the original consumer only, for one (1) year, to be free from defects in materials and workmanship under normal use. This product is designed **for personal use only**. Tanita Corporation of America reserves the right to nullify the warranty agreement should the product be used in a commercial environment. This warranty is void if the product has been tampered with or mistreated, or if the defect is related to servicing or parts not supplied by us. Our obligation under this warranty is limited solely to the charge of repairing the product, plus the cost of parts or, at the option of Tanita, replacing the product with an equivalent model. There are no express or implied warranties except as listed above.

Tanita is not liable for incidental or consequential damages for failure or malfunction of the product and any recovery may not be greater than the purchase price paid for this product. Some states do not allow limitation on how long an implied warranty lasts, or the exclusion or limitation of incidental or consequential damages, so the above limitations may not apply to you. This warranty gives you specific legal rights and you may also have other rights which vary from state to state. **No person is authorized to change the terms of this warranty.**

If Product Is Defective or Needs Repair

Do not return this product to the place of purchase; doing so may delay the processing of your warranty claim.

Call Tanita at 1-800-TANITA-8 to receive a Return Authorization Number before returning this product. Include \$12.50 for handling, return postage and insurance to the facility listed below. **Proof of purchase must accompany the product.** Because of possible loss, we recommend insuring your product, return receipt requested, when using the mail. If you do not receive a receipt within a reasonable time, start a tracer through the originating post office. It is important that you pack the product carefully prior to shipment to prevent damage in transit and that you include a letter describing in detail the specific condition requiring adjustment or repair.

Tanita Products Limited After Warranty

All terms and conditions apply as specified above in the original Tanita Limited Warranty **except** for the cost of labor and parts:

- Minimum charge for After Warranty labor is \$30 per hour, plus the cost of parts.
- You will be notified by mail or telephone of the total cost to repair your product to working condition, so prepayment can be arranged.
- Your approval is required before any repair work can be performed on your product.

Please complete the following information and retain for your records.

Model: _____ **Date Purchased:** / /

Purchased From: _____

Address: _____



Please send all returns to:
Tanita Corporation
2625 S. Clearbrook Drive
Arlington Heights, IL 60005 USA



©2000 Tanita Corporation 3/00 HDI

TANITA Corporation of Japan

14-2, 1-Chome, Maeno-Cho
Itabashi-Ku, Tokyo, Japan 174-8630
Tel: 03-3968-2123
Fax: 03-3967-3766
www.tanita.co.jp
ISO 9001 Certified

TANITA Corporation of America Inc.

2625 South Clearbrook Drive
Arlington Heights, IL 60005 USA
Tel: 847-640-9241 Fax: 847-640-9261
Toll Free: 1-800-TANITA-8
e-mail: 4health@tanita.com
www.tanita.com

TANITA France S.A.

Villa Labrouste
68 Boulevard Bourdon
92200 Neuilly-Sur Seine
Tel: 01 55 24 99 99 Fax: 01 55 24 98 68

TANITA Health Equipment H.K. Ltd.

Unit 301-303 3/F Wing On Plaza
62 Mody Road, Tsimshatsui East
Kowloon, Hong Kong
Tel: 852-2838-7111 Fax: 852-2838-8667

TANITA Europe GmbH

Dresdener Strasse 25
D-71065 Sindelfingen, Germany
Tel: 07031-6189-6
Fax: 07031-6189-71

TANITA UK Ltd.

The Barn, Philpots Close, Yiewsley,
West Drayton, Middlesex, UB7 7RY, UK
Tel: 01895-438577
Fax: 01895-438511